

DRD5S & SurfaceFrame

8" Round Surface Mount LED Area Light

New Construction









DRDHNJO Octagonal Junction Box

Project:	Type:
Product Code:	Date:

Spec Sheet V-09.23.21



- 8" round area light for lighting smaller spaces including bathrooms, closets and kitchens
- Extends just 0.6" below the ceiling plane to minimize visual profile
- Features multiple ratings to meet the demands of a wide range of situations

Application New Construction		Aperture 4" Octagonal Junction Box		
Delivered Lumens 1500 lm (17W)		Color Quality 90+ CRI, < 3-step SDCM		
Color Temperature  2700K 3000K 3500K		Input Voltage 120/277V		
Emergency Lighting Optional Emergency LED Driver for lighting up to 90 minutes in event of power failure		Dimming TRIAC/ELV 5%, 0-10V 1%		
		Shape 8" Round	Finish White	
Housing Ratings			Module Ratings	
 Code compliant for use in appropriate fire-rated assemblies up to a maximum of 2-hours	 STC/IIC Sound Rated	 ASTM E283 Certified Air Tight	 IC (Insulation Contact) Rated	 UL Listed for Wet Location
Standards			Guarantee	
  			50,000 hrs 5 years	



DRD5S & SurfaceFrame

8" Round Surface Mount LED Area Light

General New Construction
DRDHNJO Octagonal Junction Box

PRODUCT BUILDER

HOUSING

PRODUCT CODE		APPLICATION		APERTURE		OPTION	
<input type="text"/>	<input type="text"/>	<input type="text"/>	<input type="text"/>	<input type="text"/>	<input type="text"/>	<input type="text"/>	<input type="text"/>
DRDH	Housing	N	New Construction	JO	SurfaceFrame Octagonal Junction Box	[Blank]	Integrated Driver
						15OSEMS	EM Driver ¹ , 0-10V

LED MODULE

PRODUCT CODE		DIMENSION		SHAPE		LUMENS		CRI		CCT		DRIVER	
<input type="text"/>	<input type="text"/>	<input type="text"/>	<input type="text"/>	<input type="text"/>	<input type="text"/>	<input type="text"/>	<input type="text"/>	<input type="text"/>	<input type="text"/>	<input type="text"/>	<input type="text"/>	<input type="text"/>	<input type="text"/>
DRD5S	Module	8	8" Diameter	R	Round	15	1500 lm	9	90+ CRI	27	2700K	[Blank]	TRIAC/ELV
										30	3000K	O	0-10V
										35	3500K	A	Alternate ¹

¹ EM option (housing) and Alternate driver (module) must be selected together



DRD5S & SurfaceFrame

8" Round Surface Mount LED Area Light

General New Construction

DRDHNJO Octagonal Junction Box

HOUSING

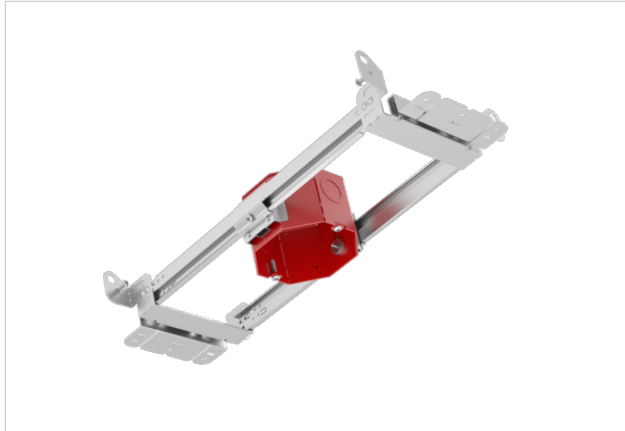

SurfaceFrame

New Construction Octagonal Junction Box

DRDHNJO

SUMMARY

JUNCTION BOX: Equipped with (4) 1/2" trade size knockouts (two side, two top) to allow straight conduit runs. Approved for 6 (three in, three out) #12 AWG 70°C through wiring conductors.

MOUNTING: Pre-installed mounting brackets allow vertical adjustment of bar hangers up to 1"

CEILING: 1/2" up to 1 3/4"

CUTOUT: 4 1/8" (105mm) octagonal opening

LISTINGS: Metallic outlet box certified UL514A, code compliant for use in appropriate fire-rated assemblies for up to 2-hours, STC/IIC Sound Rated, ASTM E283 certified Air Tight, IC (Insulation Contact) rated

WARRANTY: 5 year limited warranty

SurfaceFrame

DRDHNJO

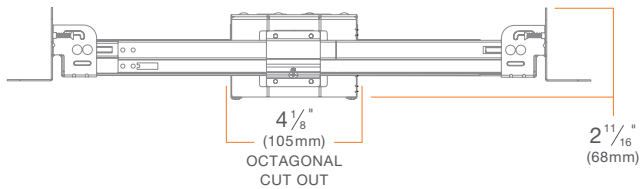

SurfaceFrame w/ Emergency Lighting

DRDHNJO EM

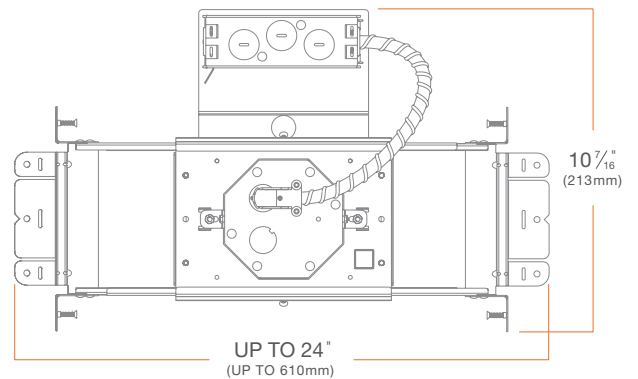
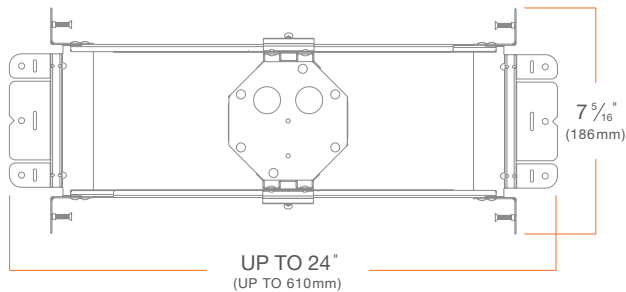
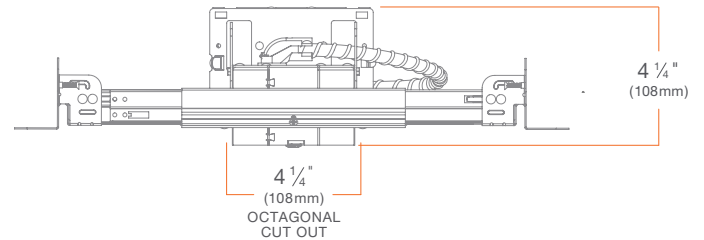



MODULE



DRD5S

8" Round Surface Mount LED Module

DRD5S

SUMMARY

LED: Samsung optimized LED array

SHAPE: 8" round

MODULE LUMENS: 1500 lm (17W)

COLOR QUALITY: 90+ CRI, less than 3-step SDCM

CCT: 2700K, 3000K, 3500K

INPUT VOLTAGE: 120/277V

DIMMING: TRIAC/ELV at 120V, 0-10V at 120/277V

MAX INPUT CURRENT (120V): 0.15 amps

MAX INPUT CURRENT (277V): 0.06 amps

POWER FACTOR: Greater than 0.9

TOTAL HARMONIC DISTORTION: Less than 20%

AMBIENT OPERATING TEMPERATURE: -20°C to 40°C

EMERGENCY LIGHTING: Optional Emergency LED Driver for lighting up to 90 minutes in event of power failure

PHOTOMETRIC TESTING: Tested in accordance to IESNA LM-79-2008

TRIM: Edgeless die-cast aluminum

LISTINGS: ENERGY STAR® qualified, California Title 24 2016 JA8 compliant, UL Listed for Wet Location, cULus Listed

LIFETIME: 50,000 hours at 70% lumen maintenance

WARRANTY: 5 year limited warranty

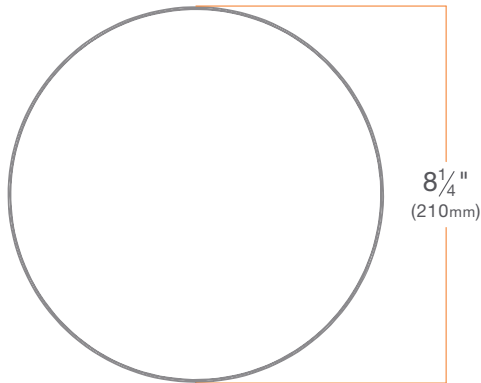
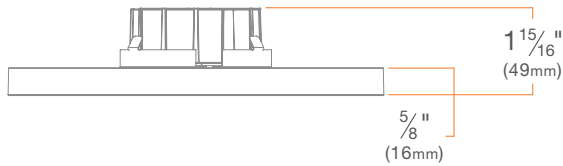



PHOTOMETRY

DRD5S 8" Round, 1500 lm, 90 CRI, 3000K **DRD5S8R15930**

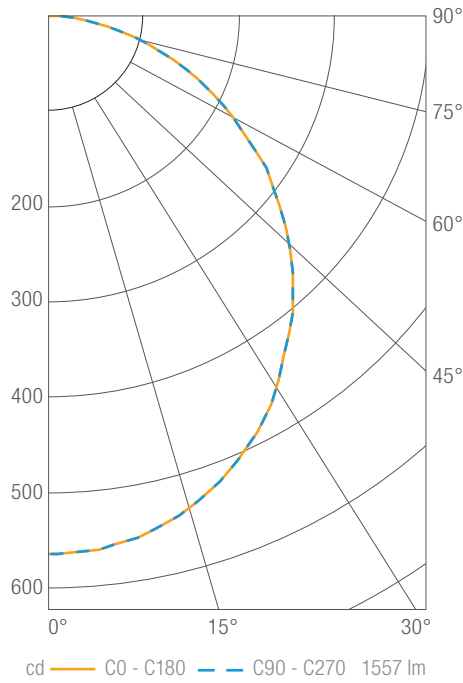

Luminous Intensity

Gamma	C 0°
0°	567
5°	564
10°	556
15°	542
20°	523
25°	499
30°	469
35°	433
40°	400
45°	360
50°	318
55°	279
60°	232
65°	189
70°	145
75°	100
80°	57
85°	25
90°	2

Values in candela

Zonal Lumen Summary

Zone	Lumens	Luminaire %
0-30	436	28
0-40	708	46
0-60	1234	79
0-90	1557	100
0-180	1557	100

Illuminance Chart

Distance from LED	Foot Candles	Diameter
3.0'	63	8.4'
6.0'	16	16.8'
9.0'	7	25.1'
12.0'	4	33.5'

Beam Angle: 110°



DIMMER COMPATIBILITY

Recommended Phase-control Dimmers (Dims down to 5% nominal measured light output)

Brand	Series	Model Number	Max Load
Cooper	Aspire	9573	17
Leviton	Vizia	VPE06	35
Lutron	CL Series	AYCL-253, DVCL-253	15
	Grafik Eye 3000	QSGR-3P, QSGR-6P	17
	Grafik Sys / Homeworks	RPM-4U	26
	Maestro CL	MACL-153M, MSCL-OP153M, MSCL-VP153M	9

Recommended 0-10V Dimmers (Dims down to 1% nominal measured light output)

Brand	Series	Model Number	Max Load
Legrand	Titan	CD4FB	100
Leviton	IllumaTech	IP710-DLZ	60
Lithonia	Synergy	ISD BC	60
Lutron	Diva	DVTV	50
	Nova	NFTV	100
	Nova	NTSTV-DV	50
	Vive-PowPak	RMJS-8T-DV-B	30
Watt Stopper	Micro-Decorator	DCLV1	30
	DLM	LMRC-211	50



SurfaceFrame Options

Shallow Recessed LED Downlight

DRD2 & SurfaceFrame

DRDHNJO Octagonal Junction Box

DRD2 & SurfaceFrame Alt/EM

Alternate Dimming and/or Emergency Lighting

DRDHNJO Octagonal Junction Box

Apex Series Shallow Recessed LED Downlight

DRD2X & SurfaceFrame

DRDHNJO Octagonal Junction Box

DRD2X & SurfaceFrame Alt/EM

Alternate Dimming and/or Emergency Lighting

DRDHNJO Octagonal Junction Box

Surface Mount LED Downlight

DRD5S & SurfaceFrame

DRDHNJO Octagonal Junction Box

DRD5S & SurfaceFrame Alt/EM

Alternate Dimming and/or Emergency Lighting

DRDHNJO Octagonal Junction Box